

Watch band



Get the tutorial

facebook.com/groups/nomadcraftsclub

instagram.com/nomadcrafts

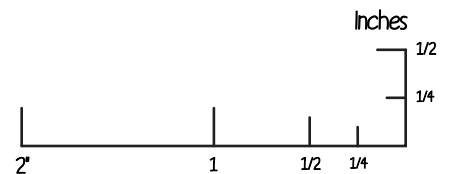
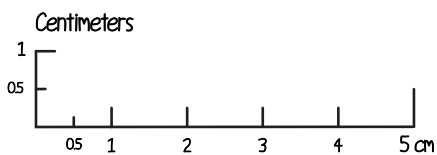
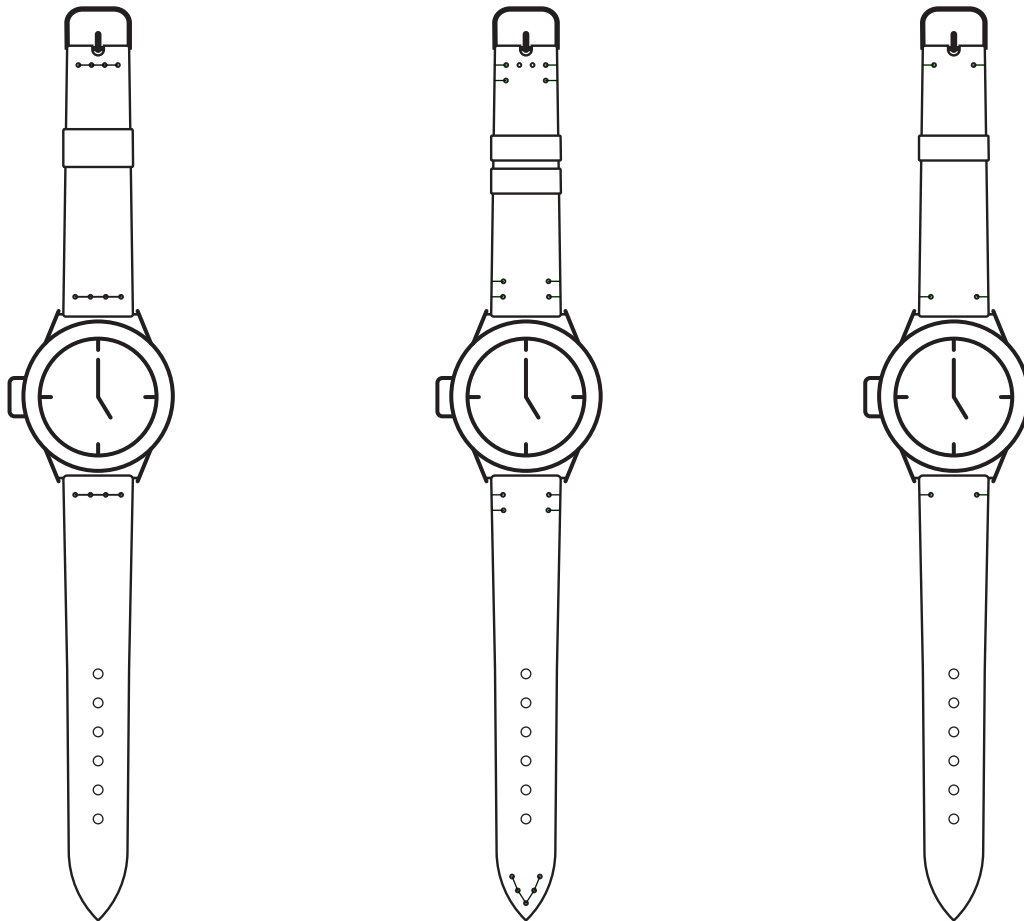

— Cut line

▨ Skiving

○ Stitching hole

○ 25mm hole punch

○ 3mm hole punch

S

R

L

Wrist size = [14.5, 18cm]

Wrist size = [16.5, 20cm]

Wrist size = [18.5, 22cm]

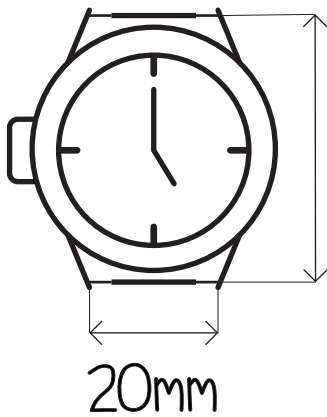
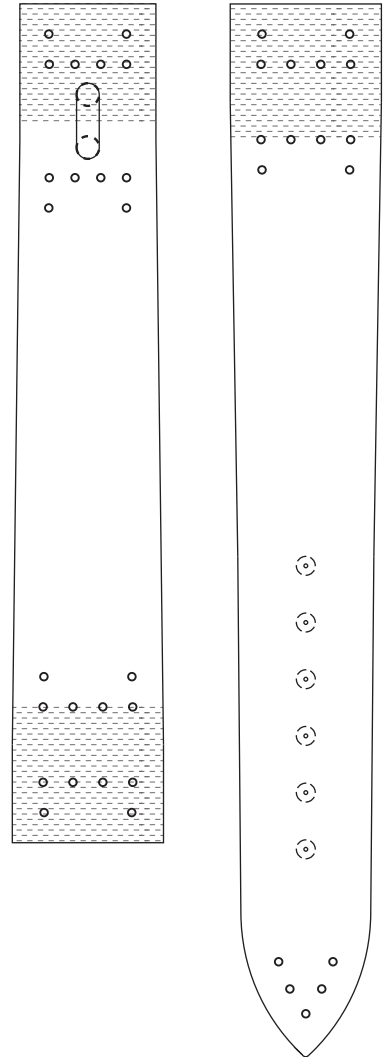
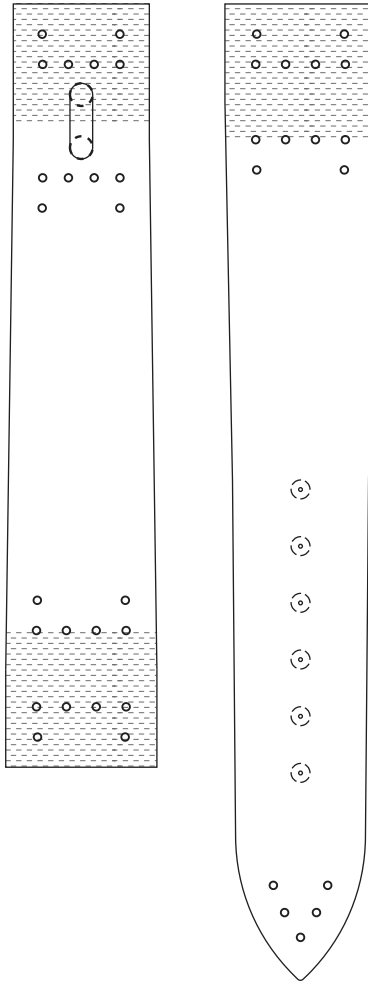
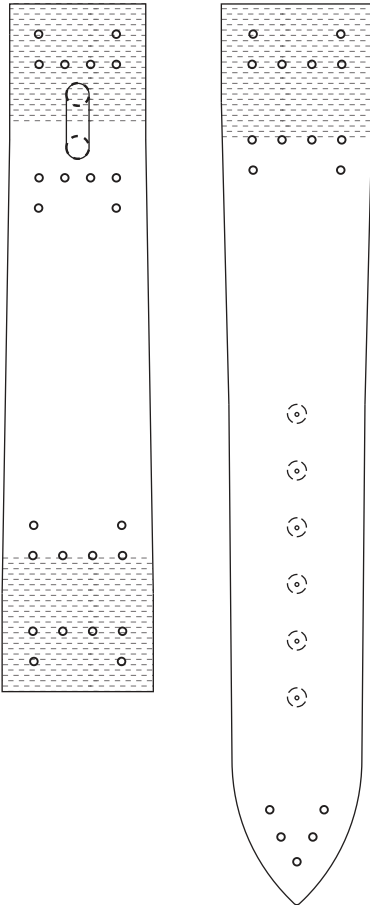

18mm

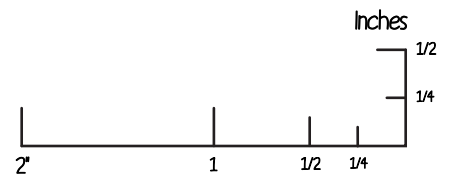

S

Wrist size = [14.5, 18cm]

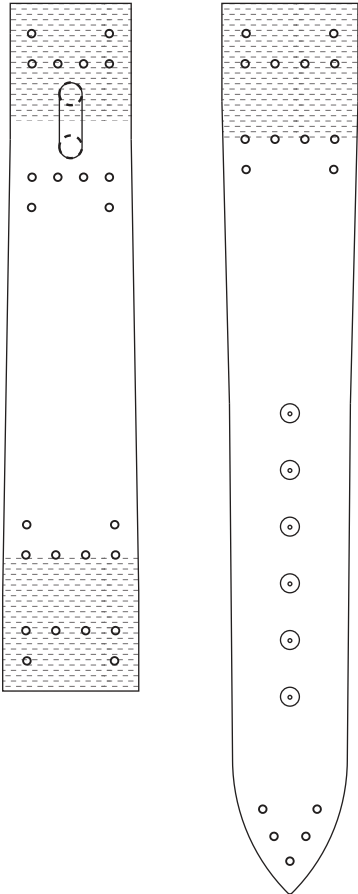

R

Wrist size = [16.5, 20cm]

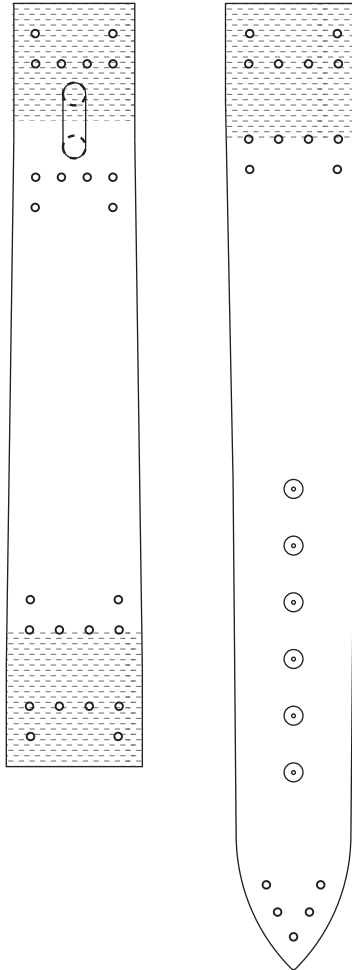

L

Wrist size = [18.5, 22cm]

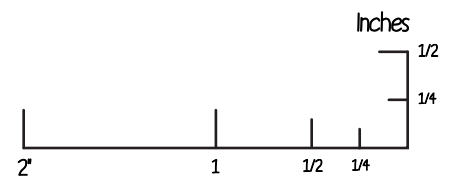
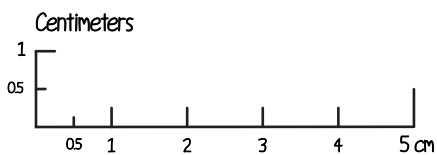
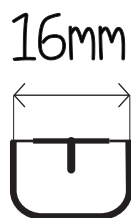
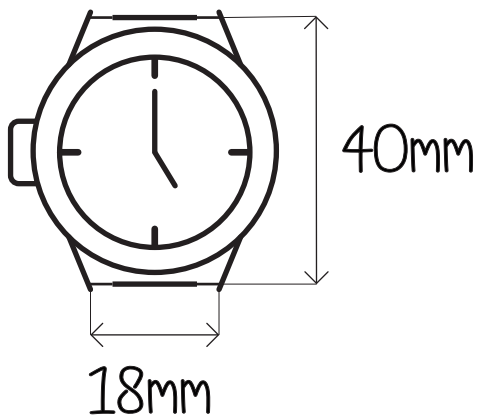
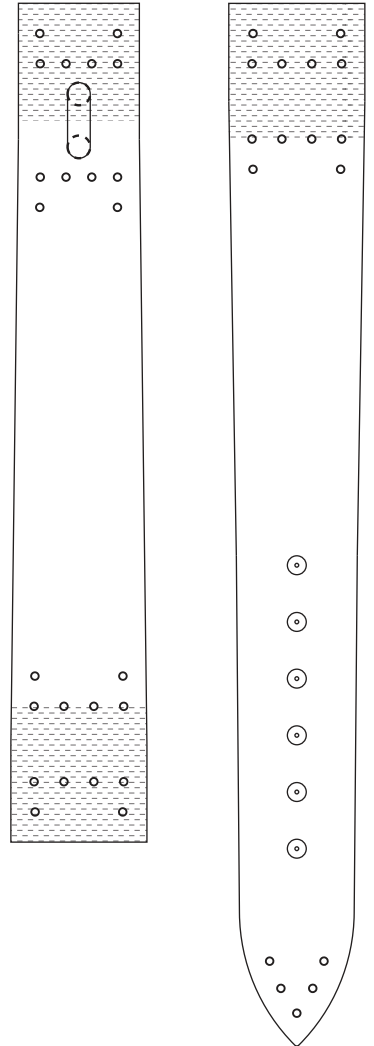

S

Wrist size = [13.5, 17.5cm]

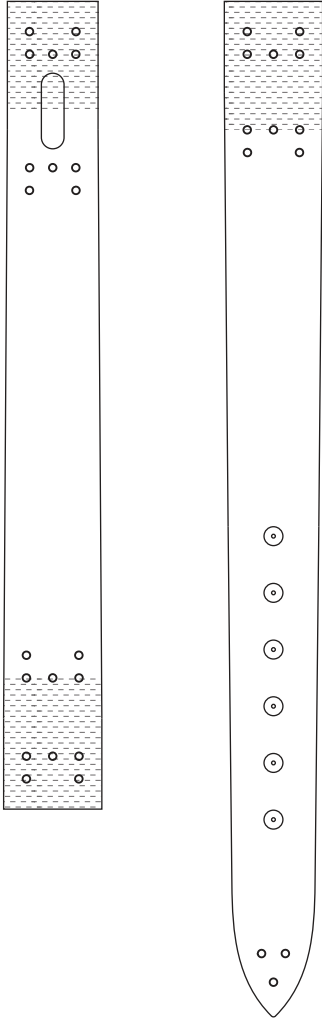

R

Wrist size = [15, 19cm]

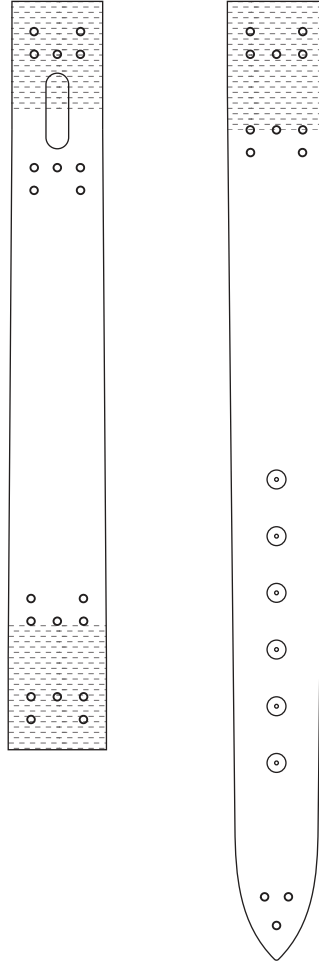

L

Wrist size = [17.5, 20.5cm]

